

Pruning Deciduous Trees

By Robert S. Logan, Extension Forestry Specialist, and
Steven B. Laursen, former Natural Resources Specialist

Nearly any question the homeowner may have about pruning trees, especially large trees, is dealt with here. Topics include the reasons for pruning, when to prune, tools and techniques, and different cutting methods. The authors also explain why topping trees is not a good idea, and why dressing tree wounds with creosote, tree paint, tar or the like is a bad idea.



MontGuide

MT199304AG reprinted 11/07

WHY PRUNE LARGE TREES?

Keep two things in mind when considering large tree pruning. First, each tree species takes on a characteristic shape and form because of its genetic makeup and local environment. Pruning may change its appearance temporarily, but not permanently. Appreciate the natural growth form of each species and try to enhance this when you prune.

Second, pruning of any kind places some stress on a tree by removing food-producing leaves, creating wounds that require energy to seal, and providing entry for disease.

This does not mean you should not prune. It means you should do it only when you have a good reason and then do it carefully and wisely.

Pruning should help the tree!

The most common reasons to prune are:

- To remove dead, diseased or dying branches,
- To remove low, crossing or hazardous branches,
- To control the size of a tree,
- To remove broken branches or tops.

When to Prune

Plant growth in our northern temperate climate begins with a flush of growth in the spring, followed by storing of manufactured food in the roots, a slowing of growth in the summer and then dormancy in the

fall. Pruning of dead branches can be done at any time of the year since you do not cut into any live tissue. For most species, it is best to prune live branches during the late winter or early spring while the tree is still dormant. This allows the plant to replace lost branches and foliage during the coming growing season and allows wounds to close and seal faster.

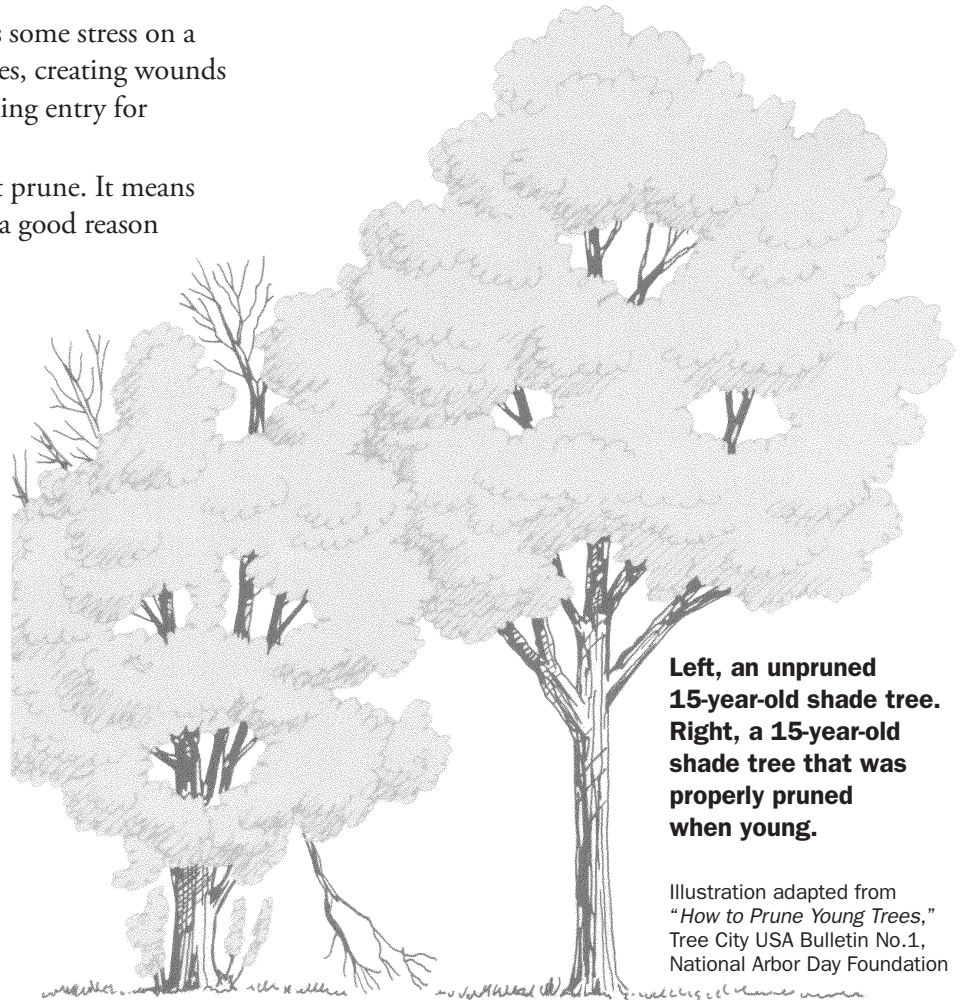

Left, an unpruned 15-year-old shade tree. Right, a 15-year-old shade tree that was properly pruned when young.

Illustration adapted from
"How to Prune Young Trees,"
Tree City USA Bulletin No.1,
National Arbor Day Foundation

Bleeding (loss of sap from wounds) can be a problem with birch, maple, elm and walnut when they are pruned in the late spring. Avoid this by pruning no later than January. This will allow freshly exposed wood to harden before sap flow begins.

Pruning in the summer will cause a loss of food production due to the removal of foliage. This restricts root development and slows the overall process of tree growth. It is better to prune a tree-in-need at any time of the year than to leave it unpruned, but summer pruning should be moderate or slight in order to discourage excessive sprouting and disease.

Tool Selection

A good pair of hand shears with scissor-action should be used to prune twigs and small branches up to 1/2-inch thick. A fine-toothed pruning saw should be used for branches up to 3 inches thick. Larger branches require a coarse-toothed pruning saw. These saws are illustrated in Figure 1.

Pruning cuts on small twigs

Regardless of your objective, all pruning cuts should be made to maximize the tree's inherent ability to close its wounds and defend itself from infection. In pruning small twigs, remove tips back to a viable bud or to the next live branch (Figure 2). Do not leave stubs. Always stand back and visualize the result of the cut before you make it.

Pruning Cuts on Large Branches

Pruning of large branches requires special care and attention to safety. Throughout the past 80 years, many myths and misconceptions have arisen concerning the method of pruning large branches. In the past decade we have learned many things about the way trees grow and heal. This new information has led us to change the way we remove branches.

The recommended method of pruning, developed over the past decade, is called natural target pruning. It is natural because the cuts are made along lines that the tree forms to aid in natural branch shedding. It is called target pruning because the tree provides target guides for the cut.

The first target is the outer side of the branch bark ridge where the branch meets the stem. The second target is the junction of the lower part of the branch and the main stem called the branch collar.

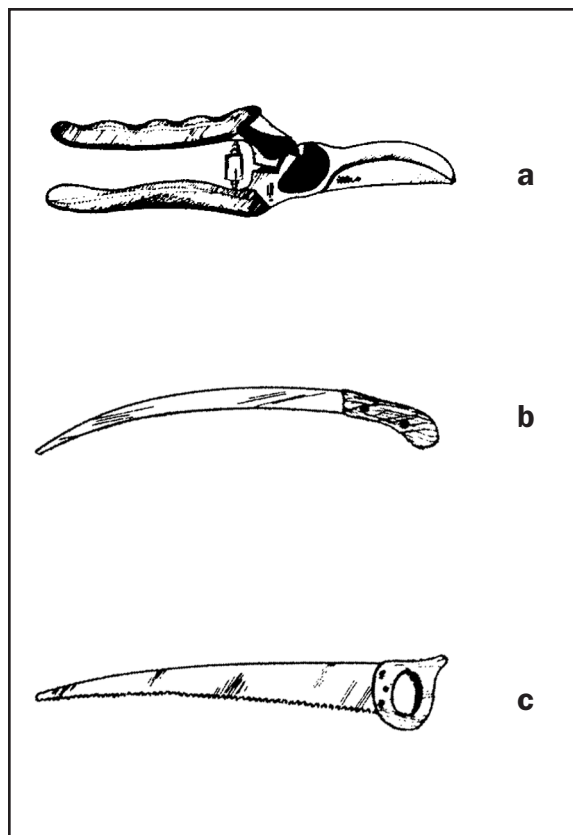

FIGURE 1. Pruning tools:
a) hand pruner
b) fine-toothed saw
c) coarse-toothed saw

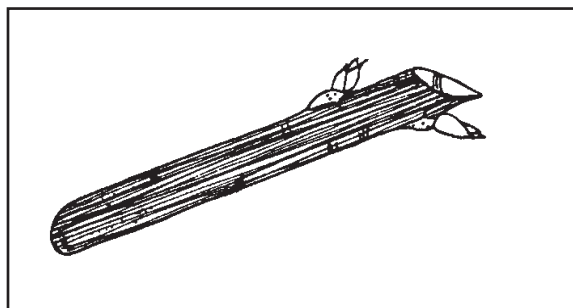

FIGURE 2. Pruning cuts on small twigs

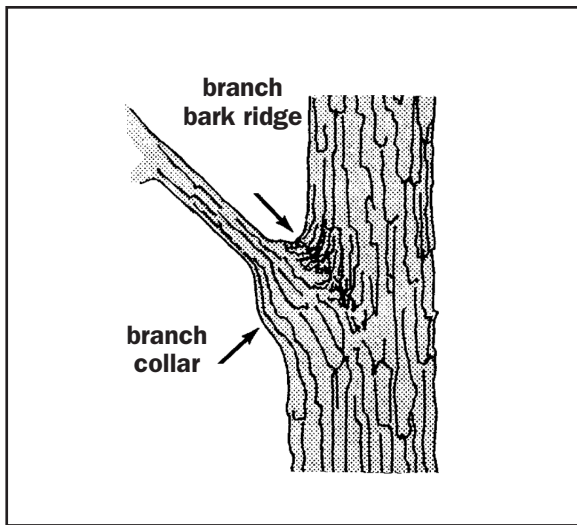

FIGURE 3. The branch collar and branch bark ridge

Every branch has internal tissues that separate it from the trunk. These tissues are instrumental in the process of wound closure and self-defense and must be protected and maintained during pruning. As this internal branch tissue forms, the bark is forced upward to form a raised ridge on the trunk that separates the branch from the trunk. This raised area is the branch bark ridge (Figure 3).

The branch collar is a slightly swollen area where the branch attaches to the trunk (Figure 3). It is most prominent on younger branches and branches that are dead or dying.

Proper pruning means removing the branch so that the branch collar is not injured or removed. No cuts should start behind the branch bark ridge. The cut usually ends up being perpendicular to the axis of the branch being removed (Figure 4).

When removing dead branches, never cut into the callus tissue which has formed at the base of the branch. Remove the branch beyond the callus ridge so that no living material is severed or detached (Figure 5).

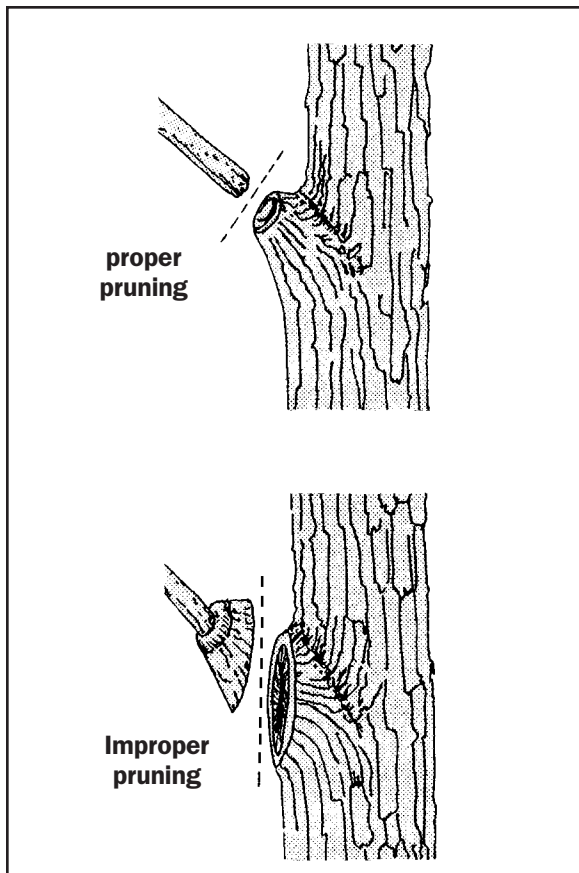

FIGURE 4. Live branch removal

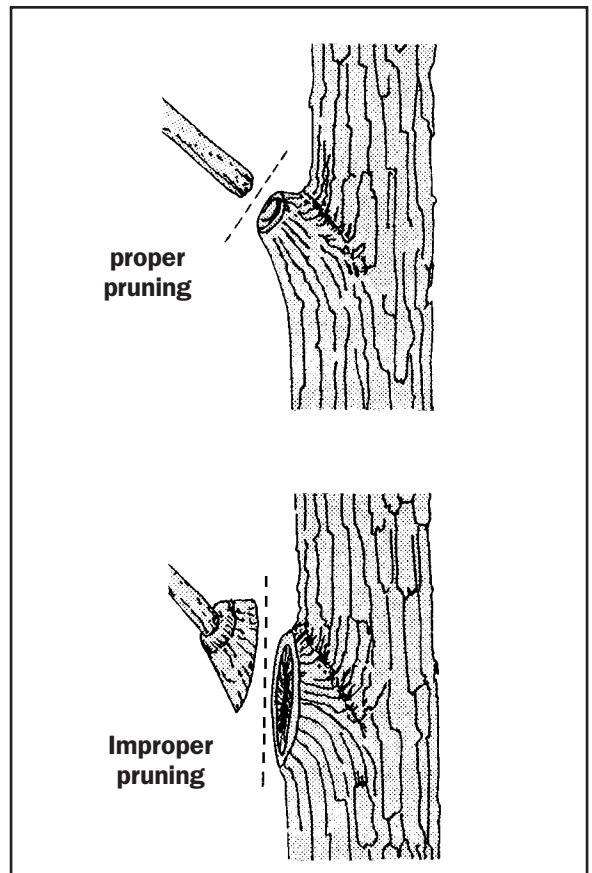

FIGURE 5. Dead branch removal

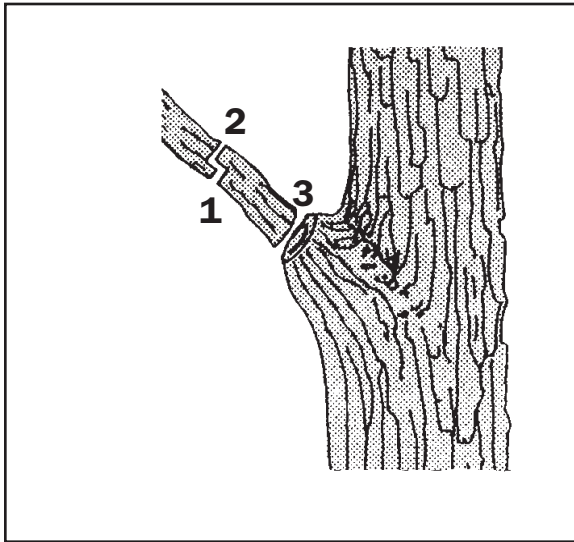

FIGURE 6.
The three-step cutting method:
1. Undercut to prevent limb breakage
2. Cut down and remove limb
3. Trim branch stub at branch collar

Three-Step Method

To remove large branches (over one inch in diameter) use the three-step cutting method (Figure 6). This removes the weight of the limb before the final cut and eliminates the possibility of stripping the bark down the side of the main trunk.

Wound Painting

Research conducted in the past several years indicates that wound dressings (creosote, tree paint, tar) do not prevent decay and that they are of limited value for wound closure. In fact, applying a dressing to exposed wood (caused by breakage or a pruning cut) only seals in disease microorganisms and creates a perfect habitat for advancing decay.

When a tree is wounded, the injured tissue is not repaired and does not heal. Trees don't heal; they seal. They have a unique defense system called compartmentalization that sets up a protective boundary between injured and healthy tissues. This area is highly protective and physically and biochemically resists the spread of infecting organisms. The most important thing you can do to enhance this natural process is to prune wisely and carefully and keep your trees vigorous and healthy.

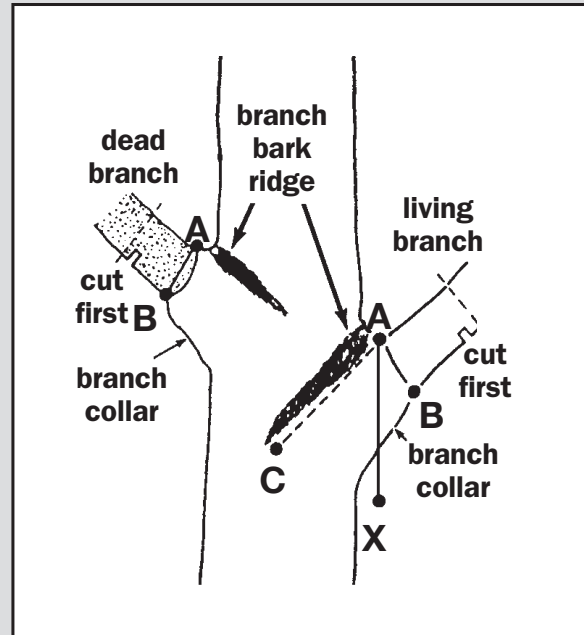

FIGURE 7. Natural target pruning

Review of Natural Target Pruning

(Refer to Figure 7)

1. Locate the branch bark ridge.
2. Find target A—outside the branch bark ridge.
3. Find target B—where branch meets collar.
4. If B cannot be found, drop an imaginary line at AX. Angle XAC equals XAB.
5. Stub cut the branch.
6. Make final cut at line AB (with power saws make final cut on upstroke).

Do not:

- make flush cuts behind the branch bark ridge.
- leave living or dead stubs.
- injure or remove the branch collar.
- paint cuts.

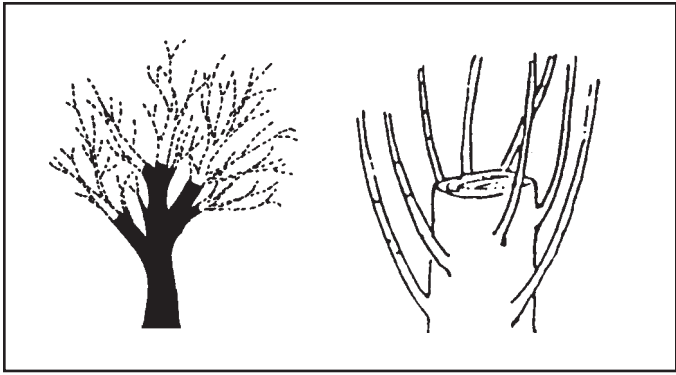

FIGURE 8. The perils of topping

Topping is Taboo

Topping, also known as hat-racking, pollarding or dehorning, is the practice of removing major portions of a large tree's crown by cutting branches to stubs and/or to the trunk (Figure 8a). Topping severely injures and infects trees, sometimes killing them outright. It drastically reduces food-production capacity, destroys natural growth habits and creates large wounds and courts disease.

Regrowth after topping is vigorous and upright from the stubs (Figure 8b). The new branches form a compact

head of broom-like terminals, often weakly attached.

After a few years, topped trees become a safety hazard to people and property. The weakly attached sprouts at the ends of remaining stubs are easily broken in high winds.

Topping is by far the most expensive form of tree pruning. The so-called tree pruning expert who tells you he can decrease the size of your tree by topping it will no doubt offer you a lower bid than the knowledgeable tree pruning expert. However, the long-term costs of hiring the topper will certainly be greater than the long-term costs of hiring the real professional. A topped tree will require continual attention and follow-up treatment for the remainder of its life. Also, the value of the tree will be significantly decreased by topping, whereas the value will increase with proper pruning. The cost of pruning must be measured over the life of the tree. The decision as to which pruner to hire must be based on many more factors than initial pruning cost.

Trees should never be topped for any reason! Better treatments are always available. If your objective is to reduce or otherwise control the growth pattern of a large tree, there are three accepted methods you can use: side pruning, drop-crotch pruning or directional pruning.

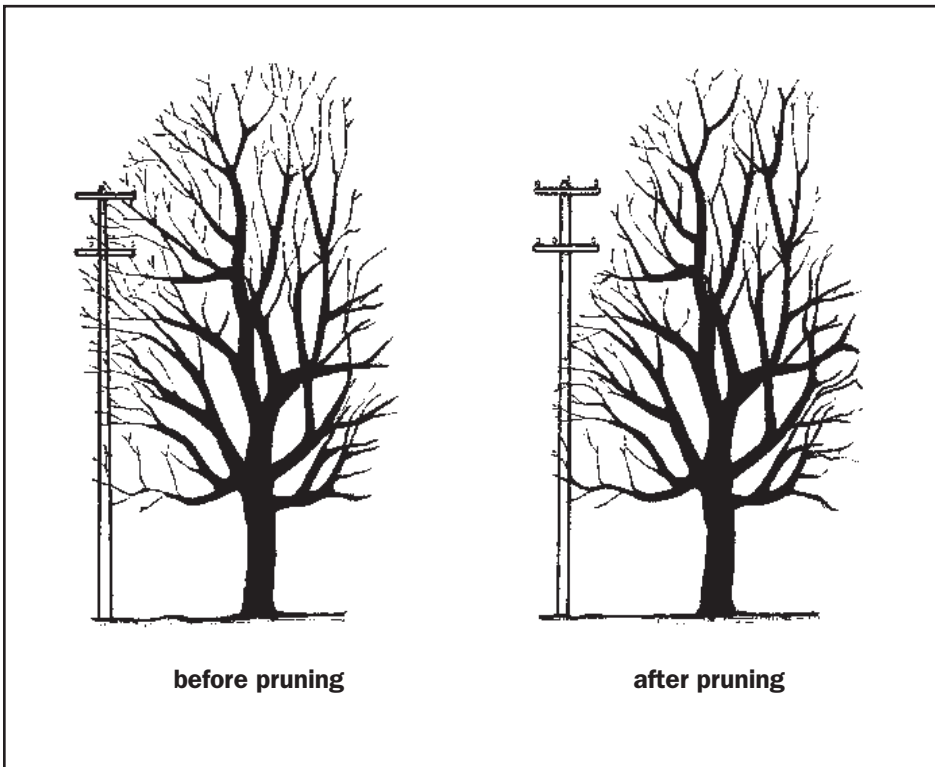

Side Pruning Method

Side pruning is the shortening back or complete removal of large lateral or side limbs where they attach to the trunk of the tree. Avoid cutting so deeply that an unsightly notch is left in the tree canopy. This method is normally practiced on mature trees. Some limbs on the opposite side of the tree also can be removed to preserve the natural form and symmetry of the tree (Figure 9). Limbs above and below a side notch may be partly shortened back to a side branch to reduce the notched effect. Do not leave stubs. Always make cuts at the base of the main branch being pruned.

FIGURE 9. Side pruning

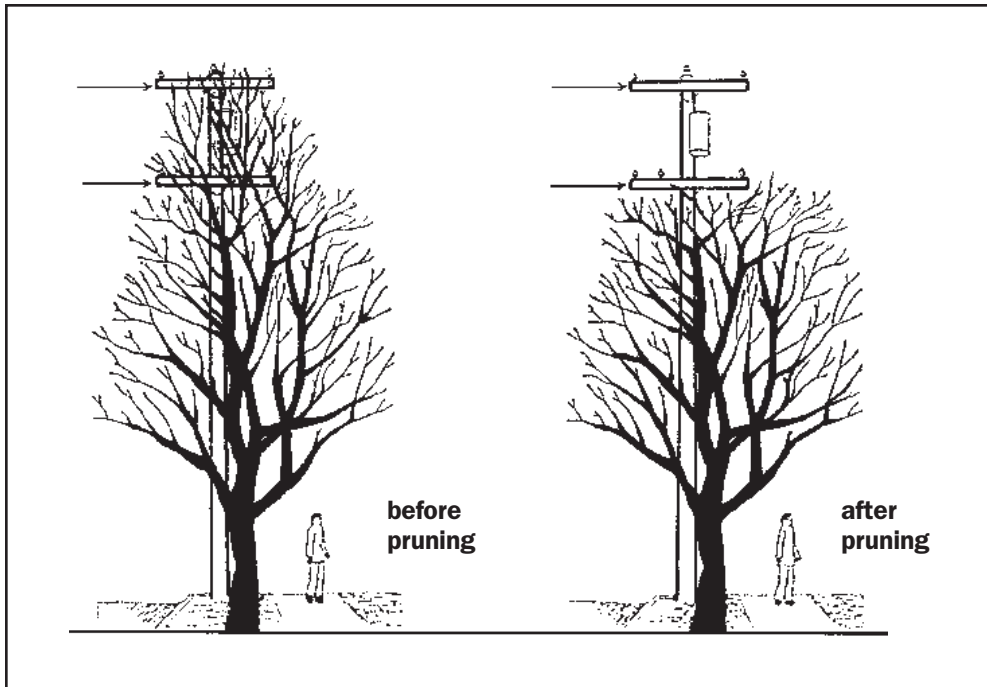

FIGURE 10. Drop-crotch pruning

Drop-crotch Pruning Method

Drop-crotch pruning is the practice of cutting back branches and/or lateral limbs to control the growth and form of larger trees. This pruning method is normally performed on mature trees, after they have become a problem and interfere with utility lines. Drop-crotch pruning is preferred because it has the longest lasting benefits for utility-line clearance and minimizes wounding. Fairly rapid healing of wounds occurs, since large lateral branches are not removed. Regrowth of new branches near the wound is minimized since most of the tree's canopy is left intact and will continue to shade the pruned area (Figure 10). Drop-crotch pruning is effective, and two or three pruning cycles done in this manner can bring a large tree under control. Most shade trees lend themselves easily to this type of pruning.

Removing large branches is a serious injury to the tree regardless of how it is done. Avoid it if possible by starting to prune early in the life of the tree. If you must remove large, terminal branches, follow these guidelines (Figure 11):

Cut line DE at an angle approximately the same angle as the angle of the branch bark ridge. Do not leave a stem stub. Do not paint the cut. Know your safety limits—call professionals when the job is too big for you.

Directional Pruning Method

Directional pruning is the practice of removing smaller branches in the tree's crown to control and direct tree growth. Directional pruning is normally practiced on

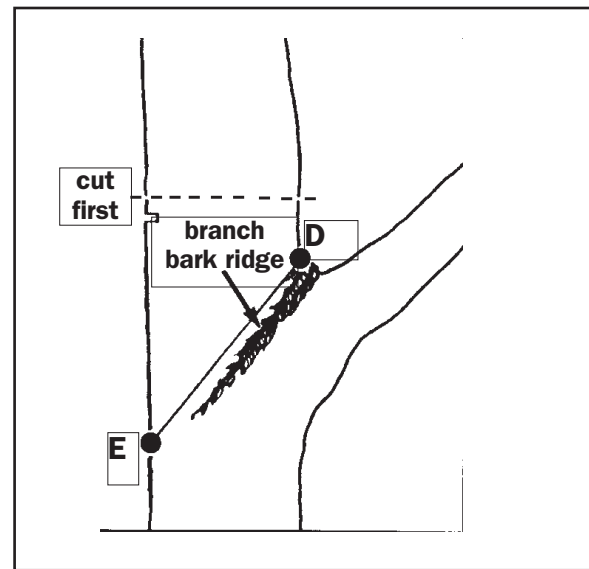

FIGURE 11. Removing large branches

trees before they reach maturity. A pruner can train the branches to grow away from utility lines and other obstructions. Directional pruning can also be used to create and maintain an opening in a tree's crown for utility lines to pass through. This type of pruning provides long lasting utility line clearance benefits and is the least injurious to the tree since wounds are small and heal rapidly. Directional pruning does not destroy the natural symmetry and beauty of the tree (Figure 12).

Under Pruning

Under pruning involves removing limbs beneath the tree crown to allow wires to pass below the tree. To preserve the symmetry of the tree, lower limbs on the opposite side of the tree should also be removed. All cuts should be to the branch collar to avoid leaving unsightly stubs. The natural shape of the tree is retained in this type of pruning and the tree can continue its normal growth (Figure 13).

Repairing Injuries of Trees

Injuries to trees which expose wood or kill bark allow insects or disease organisms to enter the tree. Proper treatment protects the tree and promotes faster callus closure.

Bark Injuries

If bark has been crushed or knocked from the trunk, remove injured bark and shape the wound. Tree wound paints have been shown to be ineffective in protecting tree wounds. Cut away damaged bark and remove isolated scraps of bark from the wound area. For fastest healing, make all margins rounded; do not point tips. Forming an elongated ellipse is not necessary (Figure 14).

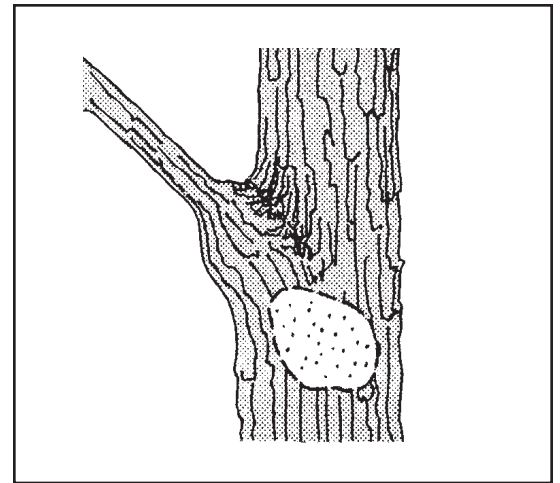

FIGURE 14. Treating bark injuries

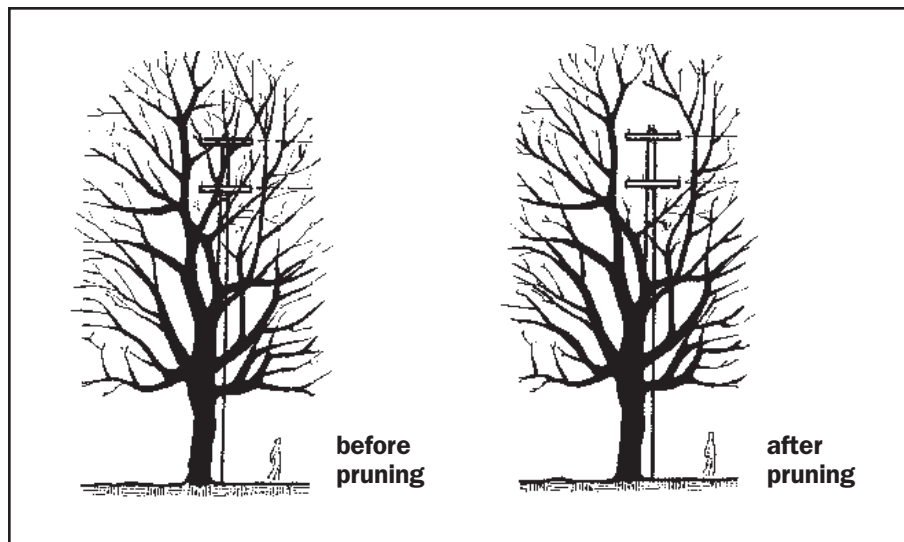

FIGURE 12. Directional pruning

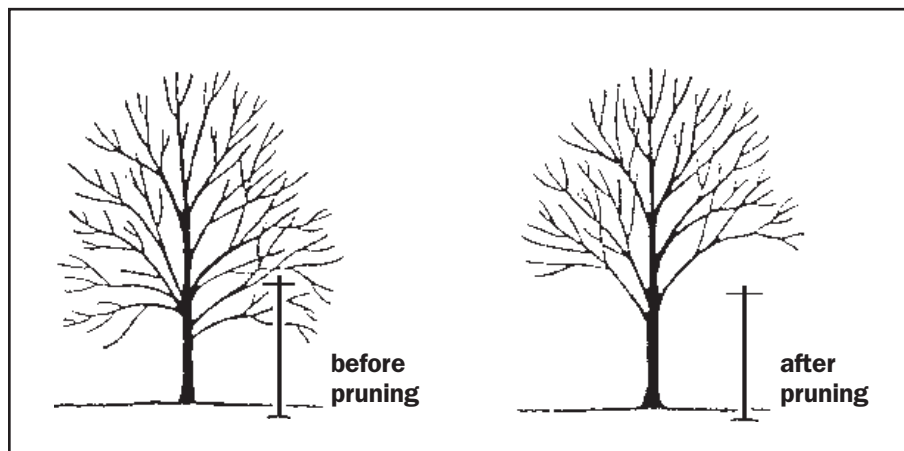

FIGURE 13. Under pruning

Cavities

If cavities are to be filled, do not clean so thoroughly that the boundary between decayed wood and sound wood is broken. Fill with nonabrasive materials. Or leave for professionals.

Injections and Implants

If you plan to have chemicals injected or implanted in your trees, make certain that it is done only by highly skilled professionals. Check injection and implant holes after one season to make certain they are closed. Injection and implant holes should be very small and shallow at the tree base, not in the roots.



<http://www.montana.edu/wwwpb/pubs/mt199304AG.pdf>

Copyright © 2006 MSU Extension Service

We encourage the use of this document for nonprofit educational purposes. This document may be reprinted for nonprofit educational purposes if no endorsement of a commercial product, service or company is stated or implied, and if appropriate credit is given to the author and the MSU Extension Service. To use these documents in electronic formats, permission must be sought from the Extension Communications Coordinator, Communications and Public Affairs, 416 Culbertson Hall, Montana State University–Bozeman, Bozeman MT 59717; **E-mail: publications@montana.edu**. To order additional publications, please contact your county or reservation MSU Extension office, visit our online catalog at www.montana.edu/publications, or e-mail orderpubs@montana.edu



The U.S. Department of Agriculture (USDA), Montana State University and the Montana State University Extension Service prohibit discrimination in all of their programs and activities on the basis of race, color, national origin, gender, religion, age, disability, political beliefs, sexual orientation, and marital and family status. Issued in furtherance of cooperative extension work in agriculture and home economics, acts of May 8 and June 30, 1914, in cooperation with the U.S. Department of Agriculture, Douglas L. Steele, Vice Provost and Director, Extension Service, Montana State University, Bozeman, MT 59717.

File under: Horticulture

A-6 (Ornamentals)

**Reprint November 2007
500-1007sda**